

Article number: 201581M1050PLE1

Description: E+G Nut GN 1582-M10-50-PL-E-1
Hygienic design

Measures

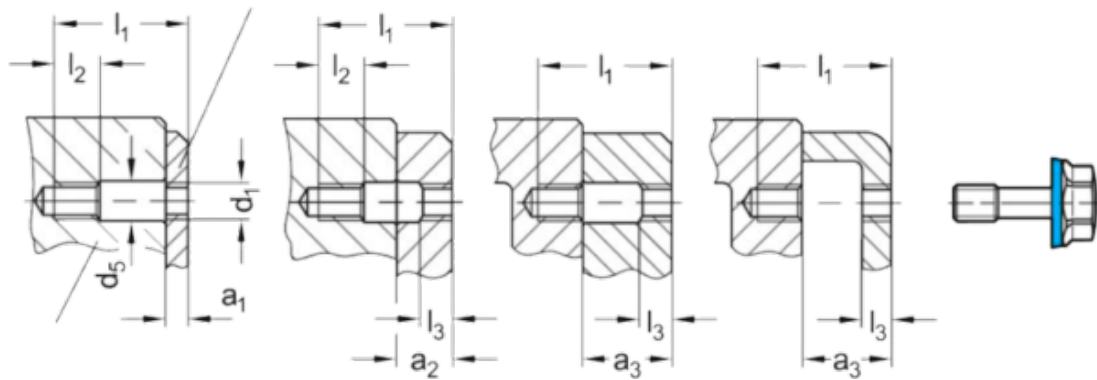
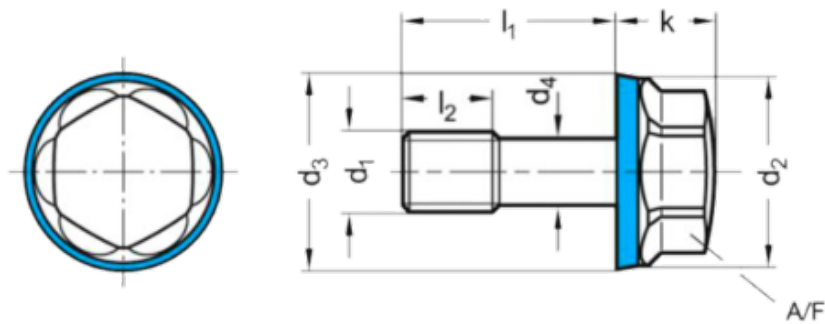

a1	= 14-24	l1	= 50
a2	= 24-28	l2	= 12
a3	= 28-38	l3	= 5
AF	= 16	Weight	= 39
d3	= 19.8		
d4 -0,2	= -		
d5	= 10.5		
k	= 9.5		